

让电尽其所能



## Hefeng Selection Manual

产品选型手册



乐清市禾丰电气有限公司  
YUEQING CITY HEFENG ELECTRIC CO.,LTD.

质量是生存的基础  
创新是发展的根本





# Company profile

## 公司简介

乐清市禾丰电气有限公司是一家专业从事工业用插头、插座、耦合器（连接器）及接插装置等电气产品的现代化企业。主要产品已经通过和正在通过 CQC, CE, POHS 等电工安全认证，继 ISO9001 质量认证，并严格按照 ISO14001 环保体系，与国内外科研机构广泛合作。

我公司技术力量雄厚，管理制度规范，具有较完善的生产质量检测设备和严谨的工艺流程，内部严格实施规范化管理和质量检验，有效的保证了产品质量，在国内建有完整的和服务网络，产品出口到欧洲，美洲，非洲、东南亚和港澳台等多个国家和地区，并在当地具有良好的品牌效应。

我公司引进国内外先进生产设备和检测设备，技术力量雄厚，能自行研制，开发高科技电器产品。并秉承专业、诚信、共赢的核心理念，视质量如生命、以科技为后盾。公司吸引了一批经验丰富的研发销售团队，将适时推出优势稳定的产品，竭诚为广大新老用户提供优质服务，与广大新老用户共同发展，创造辉煌！



所有的禾丰品都按照 IEC309-1/2、EN6039-1/2、GB11918/11919、DIN49462/49463 和 BS4343 标准，以颜色区分不同的电压及频率，参照下图可以看出不同产品之间不具互换性，因为接地插销和插套的直径比较大，并且按照电压和频率被置于不同的时钟位置。

每个产品上都详尽地标有额定电流、电压、频率、接地触头和小键或小键槽的位置。

对于额定电压超过 50V 的接插件，标明接地触头位置的符号用数字后面加上字母 h 来表示。这个数字是将连接器或插座的正面与时钟相比较，将键槽的位置定为 6 时，根据接地插套的位置确定的。

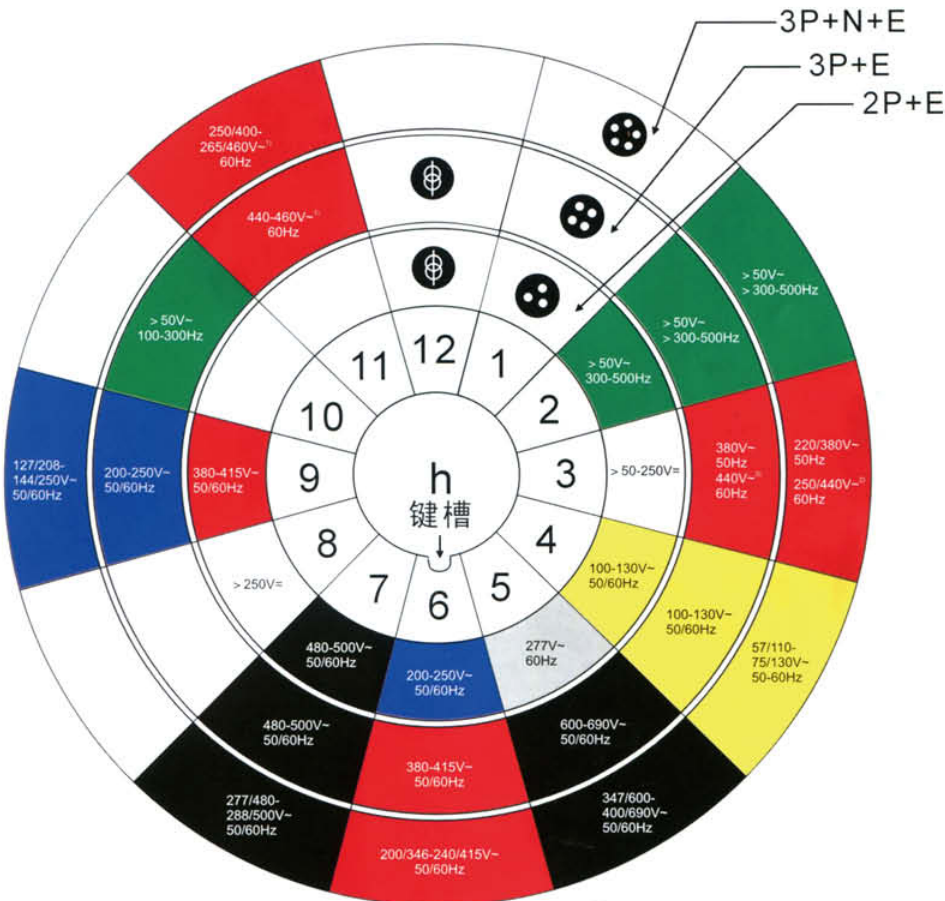

使用符号：

~ 交流电

≡ 直流电

⊕ 在隔离变压器后面

极数	频率	电压	时钟
2P、3P	50-60Hz	20-25V	
	50-60Hz	40-50V	12h
	100-200Hz	40-50V	4h
	300Hz	20-25V 40-50V	2h
	400Hz	20-25V 40-50V	3h
	400-500Hz	20-25V 40-50V	11h
		50V 以上	10h

对于额定电压低于 50v 的接插件。标明小键或小键槽位置的符号用数字后面加上字母 h 来表示。这个数字是将连接器或插座的正面与时钟相比较，将大键的位置定为 6 时，根据小键的位置确定的。

对于插头和器具插座来说，标明接地插销或小键槽位置的符号应与相应的插座或连接器中的符号相同。





110V 50a.60Hz			230V 50a.60Hz			400V 50a.60Hz			500V 50a.60Hz			>50-500V 100-300Hz			>50-500V 300-300Hz		
3pol 4h	4pol 4h	5pol 4h	3pol 6h	4pol 9h	5pol 9h	3pol 9h	4pol 6h	5pol 6h	3pol 7h	4pol 7h	5pol 7h	3pol 10h	4pol 10h	5pol 10h	3pol 2h	4pol 2h	5pol 2h

## 工业用插头、插座、耦合器（连接器）及接插装置

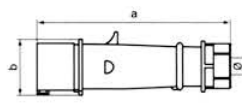
图纸/尺寸 (单位: mm)

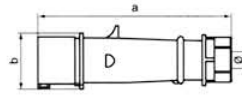
	产品名称	产品型号	电流 (A)	接地位置	电压	极数	防护等级
	插头	HFM-247	16	4h	100-130V~	2P+E	IP44
	插头	HFM-259	32	4h	100-130V~	2P+E	IP44
		尺寸		a	b	Φ	电线截面积 (mm <sup>2</sup> )
型号		HFM-247	143	57	16	1.5-4	
HFM-259		184	77	24	2.5-6		

	产品名称	产品型号	电流 (A)	接地位置	电压	极数	防护等级
	插头	HFM-248	16	6h	220-250V~	2P+E	IP44
	插头	HFM-260	32	6h	220-250V~	2P+E	IP44
		尺寸		a	b	Φ	电线截面积 (mm <sup>2</sup> )
型号		HFM-248	143	57	16	1.5-4	
HFM-260		184	77	24	2.5-6		

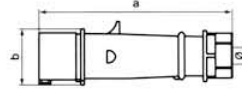

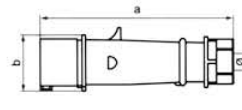



	产品名称	产品型号	电流 (A)	接地位置	电压	极数	防护等级
	插头	HFM-252	16	6h	380-415V~	3P+E	IP44
	插头	HFM-264	32	6h	380-415V~	3P+E	IP44
		尺寸		a	b	Φ	电线截面积 (mm <sup>2</sup> )
型号		HFM-252	143	63	16	1.5-4	
HFM-264		184	77	24	2.5-6		

	产品名称	产品型号	电流 (A)	接地位置	电压	极数	防护等级
	插头	HFM-3	16	6h	220-380V~ 240-415V~	3P+N+E	IP44
	插头	HFM-4	32	6h	220-380V~ 240-415V~	3P+N+E	IP44
		尺寸		a	b	Φ	电线截面积 (mm <sup>2</sup> )
型号		HFM-3	148	71.5	16	1.5-4	
HFM-4		185	77	24	2.5-6		

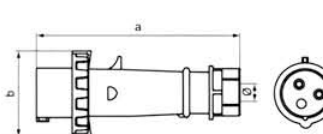
110V 50a.60Hz			230V 50a.60Hz			400V 50a.60Hz			500V 50a.60Hz			>50-500V 100-300Hz			>50-500V 300-300Hz		
3pol 4h	4pol 4h	5pol 4h	3pol 6h	4pol 9h	5pol 9h	3pol 9h	4pol 6h	5pol 6h	3pol 7h	4pol 7h	5pol 7h	3pol 10h	4pol 10h	5pol 10h	3pol 2h	4pol 2h	5pol 2h

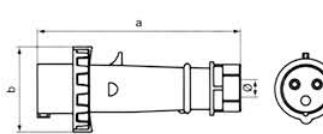
## 工业用插头、插座、耦合器（连接器）及接插装置

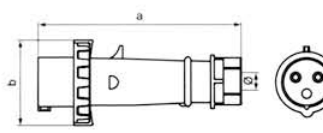
图纸/尺寸 (单位: mm)

	<table border="1"> <thead> <tr> <th>产品名称</th> <th>产品型号</th> <th>电流 (A)</th> <th>接地位置</th> <th>电压</th> <th>极数</th> <th>防护等级</th> </tr> </thead> <tbody> <tr> <td>插头</td> <td>HFM-277</td> <td>16</td> <td>4h</td> <td>100-130V~</td> <td>2P+E</td> <td>IP67</td> </tr> <tr> <td>插头</td> <td>HFM-289</td> <td>32</td> <td>4h</td> <td>100-130V~</td> <td>2P+E</td> <td>IP67</td> </tr> </tbody> </table>	产品名称	产品型号	电流 (A)	接地位置	电压	极数	防护等级	插头	HFM-277	16	4h	100-130V~	2P+E	IP67	插头	HFM-289	32	4h	100-130V~	2P+E	IP67		<table border="1"> <thead> <tr> <th rowspan="2">型号</th> <th colspan="3">尺寸</th> <th rowspan="2">电线截面积 (mm<sup>2</sup>)</th> </tr> <tr> <th>a</th> <th>b</th> <th>Φ</th> </tr> </thead> <tbody> <tr> <td>HFM-277</td> <td>143</td> <td>75</td> <td>16</td> <td>1.5-4</td> </tr> <tr> <td>HFM-289</td> <td>184</td> <td>99</td> <td>24</td> <td>2.5-6</td> </tr> </tbody> </table>	型号	尺寸			电线截面积 (mm <sup>2</sup> )	a	b	Φ	HFM-277	143	75	16	1.5-4	HFM-289	184	99	24	2.5-6
	产品名称	产品型号	电流 (A)	接地位置	电压	极数	防护等级																																			
	插头	HFM-277	16	4h	100-130V~	2P+E	IP67																																			
插头	HFM-289	32	4h	100-130V~	2P+E	IP67																																				
型号	尺寸			电线截面积 (mm <sup>2</sup> )																																						
	a	b	Φ																																							
HFM-277	143	75	16	1.5-4																																						
HFM-289	184	99	24	2.5-6																																						
	<table border="1"> <thead> <tr> <th>产品名称</th> <th>产品型号</th> <th>电流 (A)</th> <th>接地位置</th> <th>电压</th> <th>极数</th> <th>防护等级</th> </tr> </thead> <tbody> <tr> <td>插头</td> <td>HFM-278</td> <td>16</td> <td>6h</td> <td>220-250V~</td> <td>2P+E</td> <td>IP67</td> </tr> <tr> <td>插头</td> <td>HFM-290</td> <td>32</td> <td>6h</td> <td>220-250V~</td> <td>2P+E</td> <td>IP67</td> </tr> </tbody> </table>	产品名称	产品型号	电流 (A)	接地位置	电压	极数	防护等级	插头	HFM-278	16	6h	220-250V~	2P+E	IP67	插头	HFM-290	32	6h	220-250V~	2P+E	IP67		<table border="1"> <thead> <tr> <th rowspan="2">型号</th> <th colspan="3">尺寸</th> <th rowspan="2">电线截面积 (mm<sup>2</sup>)</th> </tr> <tr> <th>a</th> <th>b</th> <th>Φ</th> </tr> </thead> <tbody> <tr> <td>HFM-248</td> <td>143</td> <td>75</td> <td>16</td> <td>1.5-4</td> </tr> <tr> <td>HFM-260</td> <td>184</td> <td>99</td> <td>24</td> <td>2.5-6</td> </tr> </tbody> </table>	型号	尺寸			电线截面积 (mm <sup>2</sup> )	a	b	Φ	HFM-248	143	75	16	1.5-4	HFM-260	184	99	24	2.5-6
	产品名称	产品型号	电流 (A)	接地位置	电压	极数	防护等级																																			
	插头	HFM-278	16	6h	220-250V~	2P+E	IP67																																			
插头	HFM-290	32	6h	220-250V~	2P+E	IP67																																				
型号	尺寸			电线截面积 (mm <sup>2</sup> )																																						
	a	b	Φ																																							
HFM-248	143	75	16	1.5-4																																						
HFM-260	184	99	24	2.5-6																																						
	<table border="1"> <thead> <tr> <th>产品名称</th> <th>产品型号</th> <th>电流 (A)</th> <th>接地位置</th> <th>电压</th> <th>极数</th> <th>防护等级</th> </tr> </thead> <tbody> <tr> <td>插头</td> <td>HFM-282</td> <td>16</td> <td>6h</td> <td>380-415V~</td> <td>3P+E</td> <td>IP67</td> </tr> <tr> <td>插头</td> <td>HFM-294</td> <td>32</td> <td>6h</td> <td>380-415V~</td> <td>3P+E</td> <td>IP67</td> </tr> </tbody> </table>	产品名称	产品型号	电流 (A)	接地位置	电压	极数	防护等级	插头	HFM-282	16	6h	380-415V~	3P+E	IP67	插头	HFM-294	32	6h	380-415V~	3P+E	IP67		<table border="1"> <thead> <tr> <th rowspan="2">型号</th> <th colspan="3">尺寸</th> <th rowspan="2">电线截面积 (mm<sup>2</sup>)</th> </tr> <tr> <th>a</th> <th>b</th> <th>Φ</th> </tr> </thead> <tbody> <tr> <td>HFM-252</td> <td>143</td> <td>83</td> <td>16</td> <td>1.5-4</td> </tr> <tr> <td>HFM-264</td> <td>184</td> <td>99</td> <td>24</td> <td>2.5-6</td> </tr> </tbody> </table>	型号	尺寸			电线截面积 (mm <sup>2</sup> )	a	b	Φ	HFM-252	143	83	16	1.5-4	HFM-264	184	99	24	2.5-6
	产品名称	产品型号	电流 (A)	接地位置	电压	极数	防护等级																																			
	插头	HFM-282	16	6h	380-415V~	3P+E	IP67																																			
插头	HFM-294	32	6h	380-415V~	3P+E	IP67																																				
型号	尺寸			电线截面积 (mm <sup>2</sup> )																																						
	a	b	Φ																																							
HFM-252	143	83	16	1.5-4																																						
HFM-264	184	99	24	2.5-6																																						
	<table border="1"> <thead> <tr> <th>产品名称</th> <th>产品型号</th> <th>电流 (A)</th> <th>接地位置</th> <th>电压</th> <th>极数</th> <th>防护等级</th> </tr> </thead> <tbody> <tr> <td>插头</td> <td>HFM-288</td> <td>16</td> <td>6h</td> <td>220-380V~ 240-415V~</td> <td>3P+N+E</td> <td>IP67</td> </tr> <tr> <td>插头</td> <td>HFM-300</td> <td>32</td> <td>6h</td> <td>220-380V~ 240-415V~</td> <td>3P+N+E</td> <td>IP67</td> </tr> </tbody> </table>	产品名称	产品型号	电流 (A)	接地位置	电压	极数	防护等级	插头	HFM-288	16	6h	220-380V~ 240-415V~	3P+N+E	IP67	插头	HFM-300	32	6h	220-380V~ 240-415V~	3P+N+E	IP67		<table border="1"> <thead> <tr> <th rowspan="2">型号</th> <th colspan="3">尺寸</th> <th rowspan="2">电线截面积 (mm<sup>2</sup>)</th> </tr> <tr> <th>a</th> <th>b</th> <th>Φ</th> </tr> </thead> <tbody> <tr> <td>HFM-288</td> <td>148</td> <td>93</td> <td>16</td> <td>1.5-4</td> </tr> <tr> <td>HFM-300</td> <td>185</td> <td>107</td> <td>24</td> <td>2.5-6</td> </tr> </tbody> </table>	型号	尺寸			电线截面积 (mm <sup>2</sup> )	a	b	Φ	HFM-288	148	93	16	1.5-4	HFM-300	185	107	24	2.5-6
	产品名称	产品型号	电流 (A)	接地位置	电压	极数	防护等级																																			
	插头	HFM-288	16	6h	220-380V~ 240-415V~	3P+N+E	IP67																																			
插头	HFM-300	32	6h	220-380V~ 240-415V~	3P+N+E	IP67																																				
型号	尺寸			电线截面积 (mm <sup>2</sup> )																																						
	a	b	Φ																																							
HFM-288	148	93	16	1.5-4																																						
HFM-300	185	107	24	2.5-6																																						

110V 50a.60Hz			230V 50a.60Hz			400V 50a.60Hz			500V 50a.60Hz			>50-500V 100-300Hz			>50-500V 300-300Hz		
3pol 4h	4pol 4h	5pol 4h	3pol 6h	4pol 9h	5pol 9h	3pol 9h	4pol 6h	5pol 6h	3pol 7h	4pol 7h	5pol 7h	3pol 10h	4pol 10h	5pol 10h	3pol 2h	4pol 2h	5pol 2h

## 工业用插头、插座、耦合器（连接器）及接插装置

图纸/尺寸 (单位: mm)

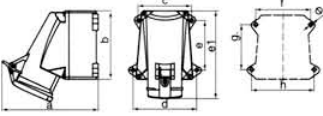
	产品名称	产品型号	电流 (A)	接地位置	电压	极数	防护等级																																															
	插头	HFM-100	16	4h	100-130V~	2P+E	IP44																																															
	插头	HFM-1420	32	4h	100-130V~	2P+E	IP44																																															
			<table border="1"> <thead> <tr> <th rowspan="2">尺寸 型号</th> <th colspan="11">尺寸</th> <th rowspan="2">电线截面 积 (mm<sup>2</sup>)</th> </tr> <tr> <th>a</th> <th>b</th> <th>c</th> <th>d</th> <th>e</th> <th>e1</th> <th>f</th> <th>g</th> <th>h</th> <th>Φ</th> </tr> </thead> <tbody> <tr> <td>HFM-100</td> <td>127</td> <td>95</td> <td>78</td> <td>88</td> <td>64</td> <td>129</td> <td>78</td> <td>64</td> <td>88</td> <td>5.5</td> <td>1.5-4</td> </tr> <tr> <td>HFM-1420</td> <td>151</td> <td>122</td> <td>79.5</td> <td>99</td> <td>90.5</td> <td>157</td> <td>79.5</td> <td>90.5</td> <td>99</td> <td>5.5</td> <td>2.5-6</td> </tr> </tbody> </table>					尺寸 型号	尺寸											电线截面 积 (mm <sup>2</sup> )	a	b	c	d	e	e1	f	g	h	Φ	HFM-100	127	95	78	88	64	129	78	64	88	5.5	1.5-4	HFM-1420	151	122	79.5	99	90.5	157	79.5	90.5	99	5.5	2.5-6
尺寸 型号	尺寸											电线截面 积 (mm <sup>2</sup> )																																										
	a	b	c	d	e	e1	f	g	h	Φ																																												
HFM-100	127	95	78	88	64	129	78	64	88	5.5	1.5-4																																											
HFM-1420	151	122	79.5	99	90.5	157	79.5	90.5	99	5.5	2.5-6																																											

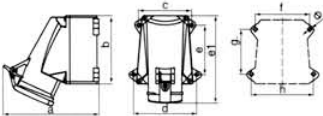
	产品名称	产品型号	电流 (A)	接地位置	电压	极数	防护等级																																															
	插头	HFM-101	16	6h	220-250V~	2P+E	IP44																																															
	插头	HFM-1421	32	6h	220-250V~	2P+E	IP44																																															
			<table border="1"> <thead> <tr> <th rowspan="2">尺寸 型号</th> <th colspan="11">尺寸</th> <th rowspan="2">电线截面 积 (mm<sup>2</sup>)</th> </tr> <tr> <th>a</th> <th>b</th> <th>c</th> <th>d</th> <th>e</th> <th>e1</th> <th>f</th> <th>g</th> <th>h</th> <th>Φ</th> </tr> </thead> <tbody> <tr> <td>HFM-101</td> <td>127</td> <td>95</td> <td>78</td> <td>88</td> <td>64</td> <td>129</td> <td>78</td> <td>64</td> <td>88</td> <td>5.5</td> <td>1.5-4</td> </tr> <tr> <td>HFM-1421</td> <td>151</td> <td>122</td> <td>79.5</td> <td>99</td> <td>90.5</td> <td>157</td> <td>79.5</td> <td>90.5</td> <td>99</td> <td>5.5</td> <td>2.5-6</td> </tr> </tbody> </table>					尺寸 型号	尺寸											电线截面 积 (mm <sup>2</sup> )	a	b	c	d	e	e1	f	g	h	Φ	HFM-101	127	95	78	88	64	129	78	64	88	5.5	1.5-4	HFM-1421	151	122	79.5	99	90.5	157	79.5	90.5	99	5.5	2.5-6
尺寸 型号	尺寸											电线截面 积 (mm <sup>2</sup> )																																										
	a	b	c	d	e	e1	f	g	h	Φ																																												
HFM-101	127	95	78	88	64	129	78	64	88	5.5	1.5-4																																											
HFM-1421	151	122	79.5	99	90.5	157	79.5	90.5	99	5.5	2.5-6																																											

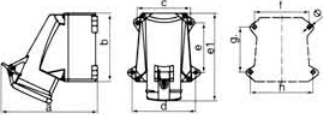
	产品名称	产品型号	电流 (A)	接地位置	电压	极数	防护等级																																															
	插头	HFM-105	16	6h	380-415V~	3P+E	IP44																																															
	插头	HFM-1425	32	6h	380-415V~	3P+E	IP44																																															
			<table border="1"> <thead> <tr> <th rowspan="2">尺寸 型号</th> <th colspan="11">尺寸</th> <th rowspan="2">电线截面 积 (mm<sup>2</sup>)</th> </tr> <tr> <th>a</th> <th>b</th> <th>c</th> <th>d</th> <th>e</th> <th>e1</th> <th>f</th> <th>g</th> <th>h</th> <th>Φ</th> </tr> </thead> <tbody> <tr> <td>HFM-105</td> <td>131</td> <td>95</td> <td>78</td> <td>88</td> <td>64</td> <td>129</td> <td>78</td> <td>64</td> <td>88</td> <td>5.5</td> <td>1.5-4</td> </tr> <tr> <td>HFM-1425</td> <td>151</td> <td>122</td> <td>79.5</td> <td>99</td> <td>90.5</td> <td>157</td> <td>79.5</td> <td>90.5</td> <td>99</td> <td>5.5</td> <td>2.5-6</td> </tr> </tbody> </table>					尺寸 型号	尺寸											电线截面 积 (mm <sup>2</sup> )	a	b	c	d	e	e1	f	g	h	Φ	HFM-105	131	95	78	88	64	129	78	64	88	5.5	1.5-4	HFM-1425	151	122	79.5	99	90.5	157	79.5	90.5	99	5.5	2.5-6
尺寸 型号	尺寸											电线截面 积 (mm <sup>2</sup> )																																										
	a	b	c	d	e	e1	f	g	h	Φ																																												
HFM-105	131	95	78	88	64	129	78	64	88	5.5	1.5-4																																											
HFM-1425	151	122	79.5	99	90.5	157	79.5	90.5	99	5.5	2.5-6																																											

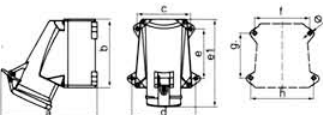
	产品名称	产品型号	电流 (A)	接地位置	电压	极数	防护等级																																															
	插头	HFM-111	16	6h	220-380V~ 240-415V~	3P+N+E	IP44																																															
	插头	HFM-1557	32	6h	220-380V~ 240-415V~	3P+N+E	IP44																																															
			<table border="1"> <thead> <tr> <th rowspan="2">尺寸 型号</th> <th colspan="11">尺寸</th> <th rowspan="2">电线截面 积 (mm<sup>2</sup>)</th> </tr> <tr> <th>a</th> <th>b</th> <th>c</th> <th>d</th> <th>e</th> <th>e1</th> <th>f</th> <th>g</th> <th>h</th> <th>Φ</th> </tr> </thead> <tbody> <tr> <td>HFM-111</td> <td>138</td> <td>95</td> <td>78</td> <td>88</td> <td>64</td> <td>129</td> <td>78</td> <td>64</td> <td>88</td> <td>5.5</td> <td>1.5-4</td> </tr> <tr> <td>HFM-1557</td> <td>160</td> <td>122</td> <td>79.5</td> <td>99</td> <td>90.5</td> <td>160</td> <td>79.5</td> <td>90.5</td> <td>99</td> <td>5.5</td> <td>2.5-6</td> </tr> </tbody> </table>					尺寸 型号	尺寸											电线截面 积 (mm <sup>2</sup> )	a	b	c	d	e	e1	f	g	h	Φ	HFM-111	138	95	78	88	64	129	78	64	88	5.5	1.5-4	HFM-1557	160	122	79.5	99	90.5	160	79.5	90.5	99	5.5	2.5-6
尺寸 型号	尺寸											电线截面 积 (mm <sup>2</sup> )																																										
	a	b	c	d	e	e1	f	g	h	Φ																																												
HFM-111	138	95	78	88	64	129	78	64	88	5.5	1.5-4																																											
HFM-1557	160	122	79.5	99	90.5	160	79.5	90.5	99	5.5	2.5-6																																											



110V 50a.60Hz			230V 50a.60Hz			400V 50a.60Hz			500V 50a.60Hz			>50-500V 100-300Hz			>50-500V 300-300Hz		
3pol 4h	4pol 4h	5pol 4h	3pol 6h	4pol 9h	5pol 9h	3pol 9h	4pol 6h	5pol 6h	3pol 7h	4pol 7h	5pol 7h	3pol 10h	4pol 10h	5pol 10h	3pol 2h	4pol 2h	5pol 2h

## 工业用插头、插座、耦合器（连接器）及接插装置

图纸/尺寸 (单位: mm)



产品名称	产品型号	电流 (A)	接地位置	电压	极数	防护等级
插头	HFM-1193	16	4h	100-130V~	2P+E	IP67
插头	HFM-1201	32	4h	100-130V~	2P+E	IP67

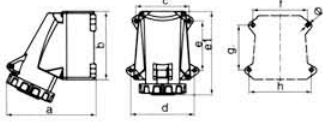

尺寸 型号	尺寸											电线截面 面积 (mm <sup>2</sup> )
	a	b	c	d	e	e1	f	g	h	Φ		
HFM-1193	127	95	78	88	64	131	78	64	88	5.5	1.5-4	
HFM-1201	143	122	79.5	99	90.5	160	79.5	90.5	99	5.5	2.5-6	



产品名称	产品型号	电流 (A)	接地位置	电压	极数	防护等级
插头	HFM-1192	16	6h	220-250V~	2P+E	IP67
插头	HFM-1202	32	6h	220-250V~	2P+E	IP67

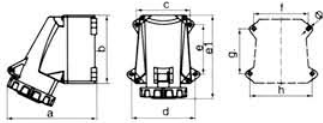

尺寸 型号	尺寸											电线截面 面积 (mm <sup>2</sup> )
	a	b	c	d	e	e1	f	g	h	Φ		
HFM-1192	127	95	78	88	64	131	78	64	88	5.5	1.5-4	
HFM-1202	143	122	79.5	99	90.5	160	79.5	90.5	99	5.5	2.5-6	



产品名称	产品型号	电流 (A)	接地位置	电压	极数	防护等级
插头	HFM-1196	16	6h	380-415V~	3P+E	IP67
插头	HFM-1206	32	6h	380-415V~	3P+E	IP67

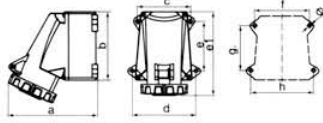

尺寸 型号	尺寸											电线截面 面积 (mm <sup>2</sup> )
	a	b	c	d	e	e1	f	g	h	Φ		
HFM-1196	127	95	78	88	64	131	78	64	88	5.5	1.5-4	
HFM-1206	143	122	79.5	99	90.5	160	79.5	90.5	99	5.5	2.5-6	



产品名称	产品型号	电流 (A)	接地位置	电压	极数	防护等级
插头	HFM-1200	16	6h	220-380V~ 240-415V~	3P+N+E	IP67
插头	HFM-1210	32	6h	220-380V~ 240-415V~	3P+N+E	IP67

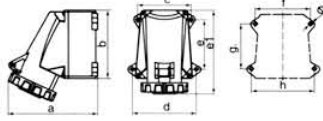

尺寸 型号	尺寸											电线截面 面积 (mm <sup>2</sup> )
	a	b	c	d	e	e1	f	g	h	Φ		
HFM-1200	138	95	78	88	64	134	78	64	88	5.5	1.5-4	
HFM-1210	160	122	79.5	99	90.5	165	79.5	90.5	99	5.5	2.5-6	





110V 50a.60Hz			230V 50a.60Hz			400V 50a.60Hz			500V 50a.60Hz			>50-500V 100-300Hz			>50-500V 300-300Hz		
3pol 4h	4pol 4h	5pol 4h	3pol 6h	4pol 9h	5pol 9h	3pol 9h	4pol 6h	5pol 6h	3pol 7h	4pol 7h	5pol 7h	3pol 10h	4pol 10h	5pol 10h	3pol 2h	4pol 2h	5pol 2h

## 工业用插头、插座、耦合器（连接器）及接插装置

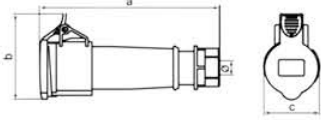
图纸/尺寸 (单位: mm)

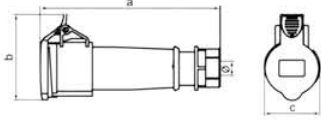
	产品名称	产品型号	电流 (A)	接地位置	电压	极数	防护等级																	
	插头	HFM-1571	16	4h	100-130V~	2P+E	IP44																	
	插头	HFM-3400	32	4h	100-130V~	2P+E	IP44																	
			<table border="1"> <thead> <tr> <th>型号</th> <th>a</th> <th>b</th> <th>c</th> <th>Φ</th> <th>电线截面积 (mm<sup>2</sup>)</th> </tr> </thead> <tbody> <tr> <td>HFM-1571</td> <td>163</td> <td>89</td> <td>60</td> <td>16</td> <td>1.5-4</td> </tr> <tr> <td>HFM-3400</td> <td>211</td> <td>105</td> <td>82</td> <td>24</td> <td>2.5-6</td> </tr> </tbody> </table>				型号	a	b	c	Φ	电线截面积 (mm <sup>2</sup> )	HFM-1571	163	89	60	16	1.5-4	HFM-3400	211	105	82	24	2.5-6
型号	a	b	c	Φ	电线截面积 (mm <sup>2</sup> )																			
HFM-1571	163	89	60	16	1.5-4																			
HFM-3400	211	105	82	24	2.5-6																			

	产品名称	产品型号	电流 (A)	接地位置	电压	极数	防护等级																	
	插头	HFM-510	16	6h	220-250V~	2P+E	IP44																	
	插头	HFM-522	32	6h	220-250V~	2P+E	IP44																	
			<table border="1"> <thead> <tr> <th>型号</th> <th>a</th> <th>b</th> <th>c</th> <th>Φ</th> <th>电线截面积 (mm<sup>2</sup>)</th> </tr> </thead> <tbody> <tr> <td>HFM-510</td> <td>163</td> <td>89</td> <td>60</td> <td>16</td> <td>1.5-4</td> </tr> <tr> <td>HFM-522</td> <td>211</td> <td>105</td> <td>82</td> <td>24</td> <td>2.5-6</td> </tr> </tbody> </table>				型号	a	b	c	Φ	电线截面积 (mm <sup>2</sup> )	HFM-510	163	89	60	16	1.5-4	HFM-522	211	105	82	24	2.5-6
型号	a	b	c	Φ	电线截面积 (mm <sup>2</sup> )																			
HFM-510	163	89	60	16	1.5-4																			
HFM-522	211	105	82	24	2.5-6																			

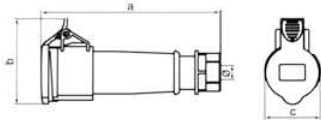
	产品名称	产品型号	电流 (A)	接地位置	电压	极数	防护等级																	
	插头	HFM-514S	16	6h	380-415V~	3P+E	IP44																	
	插头	HFM-526	32	6h	380-415V~	3P+E	IP44																	
			<table border="1"> <thead> <tr> <th>型号</th> <th>a</th> <th>b</th> <th>c</th> <th>Φ</th> <th>电线截面积 (mm<sup>2</sup>)</th> </tr> </thead> <tbody> <tr> <td>HFM-514S</td> <td>163</td> <td>91</td> <td>60</td> <td>16</td> <td>1.5-4</td> </tr> <tr> <td>HFM-526</td> <td>211</td> <td>105</td> <td>82</td> <td>24</td> <td>2.5-6</td> </tr> </tbody> </table>				型号	a	b	c	Φ	电线截面积 (mm <sup>2</sup> )	HFM-514S	163	91	60	16	1.5-4	HFM-526	211	105	82	24	2.5-6
型号	a	b	c	Φ	电线截面积 (mm <sup>2</sup> )																			
HFM-514S	163	91	60	16	1.5-4																			
HFM-526	211	105	82	24	2.5-6																			

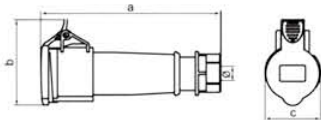
	产品名称	产品型号	电流 (A)	接地位置	电压	极数	防护等级																	
	插头	HFM-5	16	6h	220-380V~ 240-415V~	3P+N+E	IP44																	
	插头	HFM-6	32	6h	220-380V~ 240-415V~	3P+N+E	IP44																	
			<table border="1"> <thead> <tr> <th>型号</th> <th>a</th> <th>b</th> <th>c</th> <th>Φ</th> <th>电线截面积 (mm<sup>2</sup>)</th> </tr> </thead> <tbody> <tr> <td>HFM-5</td> <td>168</td> <td>99</td> <td>77</td> <td>16</td> <td>1.5-4</td> </tr> <tr> <td>HFM-6</td> <td>211</td> <td>105</td> <td>86</td> <td>24</td> <td>2.5-6</td> </tr> </tbody> </table>				型号	a	b	c	Φ	电线截面积 (mm <sup>2</sup> )	HFM-5	168	99	77	16	1.5-4	HFM-6	211	105	86	24	2.5-6
型号	a	b	c	Φ	电线截面积 (mm <sup>2</sup> )																			
HFM-5	168	99	77	16	1.5-4																			
HFM-6	211	105	86	24	2.5-6																			

110V 50a.60Hz			230V 50a.60Hz			400V 50a.60Hz			500V 50a.60Hz			>50-500V 100-300Hz			>50-500V 300-300Hz		
3pol 4h	4pol 4h	5pol 4h	3pol 6h	4pol 9h	5pol 9h	3pol 9h	4pol 6h	5pol 6h	3pol 7h	4pol 7h	5pol 7h	3pol 10h	4pol 10h	5pol 10h	3pol 2h	4pol 2h	5pol 2h

## 工业用插头、插座、耦合器（连接器）及接插装置

图纸/尺寸 (单位: mm)

产品名称	产品型号	电流 (A)	接地位置	电压	极数	防护等级	尺寸					
							型号	a	b	Φ1	Φ2	电线截面积 (mm <sup>2</sup> )
插头	HFM-539	16	4h	100-130V~	2P+E	IP67	HFM-539	166	81	16	72	1.5-4
插头	HFM-551	32	4h	100-130V~	2P+E	IP67	HFM-551	216	98	24	94	2.5-6

产品名称	产品型号	电流 (A)	接地位置	电压	极数	防护等级	尺寸					
							型号	a	b	Φ1	Φ2	电线截面积 (mm <sup>2</sup> )
插头	HFM-540	16	6h	220-250V~	2P+E	IP67	HFM-540	166	81	16	72	1.5-4
插头	HFM-552	32	6h	220-250V~	2P+E	IP67	HFM-552	216	98	24	94	2.5-6

产品名称	产品型号	电流 (A)	接地位置	电压	极数	防护等级	尺寸					
							型号	a	b	Φ1	Φ2	电线截面积 (mm <sup>2</sup> )
插头	HFM-544	16	6h	380-415V~	3P+E	IP67	HFM-544	168	86	16	80	1.5-4
插头	HFM-556	32	6h	380-415V~	3P+E	IP67	HFM-556	216	98	24	94	2.5-6

产品名称	产品型号	电流 (A)	接地位置	电压	极数	防护等级	尺寸					
							型号	a	b	Φ1	Φ2	电线截面积 (mm <sup>2</sup> )
插头	HFM-550	16	6h	220-380V~ 240-415V~	3P+N+E	IP67	HFM-550	173	93	16	88	1.5-4
插头	HFM-562	32	6h	220-380V~ 240-415V~	3P+N+E	IP67	HFM-562	214	106	24	102	2.5-6

110V 50a.60Hz			230V 50a.60Hz			400V 50a.60Hz			500V 50a.60Hz			>50-500V 100-300Hz			>50-500V 300-300Hz		
3pol 4h	4pol 4h	5pol 4h	3pol 6h	4pol 9h	5pol 9h	3pol 9h	4pol 6h	5pol 6h	3pol 7h	4pol 7h	5pol 7h	3pol 10h	4pol 10h	5pol 10h	3pol 2h	4pol 2h	5pol 2h

## 工业用插头、插座、耦合器（连接器）及接插装置

图纸/尺寸 (单位: mm)

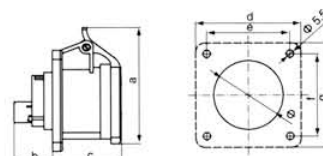
	产品名称	产品型号	电流 (A)	接地位置	电压	极数	防护等级		
	插头	HFM-1365	16	4h	100-130V~	2P+E	IP44		
	插头	HFM-1394	32	4h	100-130V~	2P+E	IP44		
	尺寸								电线截面积 (mm <sup>2</sup> )
	型号	a	b	c	d	e	f	g	
	HFM-1365	88	33	51	75	61	61	75	55
HFM-1394	104	41	62	75	61	61	75	63	2.5-6

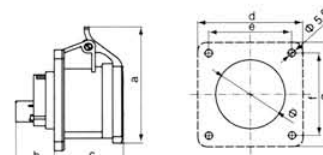
	产品名称	产品型号	电流 (A)	接地位置	电压	极数	防护等级		
	插头	HFM-1366	16	6h	220-250V~	2P+E	IP44		
	插头	HFM-1395	32	6h	220-250V~	2P+E	IP44		
	尺寸								电线截面积 (mm <sup>2</sup> )
	型号	a	b	c	d	e	f	g	
	HFM-1366	88	33	51	75	61	61	75	55
HFM-1395	104	41	62	75	61	61	75	63	2.5-6

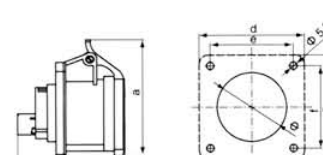
	产品名称	产品型号	电流 (A)	接地位置	电压	极数	防护等级		
	插头	HFM-1390	16	6h	380-415V~	3P+E	IP44		
	插头	HFM-1399	32	6h	380-415V~	3P+E	IP44		
	尺寸								电线截面积 (mm <sup>2</sup> )
	型号	a	b	c	d	e	f	g	
	HFM-1390	91	33	51	75	61	61	75	55
HFM-1399	104	41	62	75	61	61	75	63	2.5-6

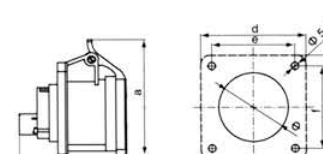
	产品名称	产品型号	电流 (A)	接地位置	电压	极数	防护等级		
	插头	HFM-1385	16	6h	220-380V~ 240-415V~	3P+N+E	IP44		
	插头	HFM-3451	32	6h	220-380V~ 240-415V~	3P+N+E	IP44		
	尺寸								电线截面积 (mm <sup>2</sup> )
	型号	a	b	c	d	e	f	g	
	HFM-1385	100	31	52	75	61	61	75	55
HFM-3451	113	40	61	75	61	61	75	63	2.5-6





110V 50a.60Hz			230V 50a.60Hz			400V 50a.60Hz			500V 50a.60Hz			>50-500V 100-300Hz			>50-500V 300-300Hz		
3pol 4h	4pol 4h	5pol 4h	3pol 6h	4pol 9h	5pol 9h	3pol 9h	4pol 6h	5pol 6h	3pol 7h	4pol 7h	5pol 7h	3pol 10h	4pol 10h	5pol 10h	3pol 2h	4pol 2h	5pol 2h

## 工业用插头、插座、耦合器（连接器）及接插装置

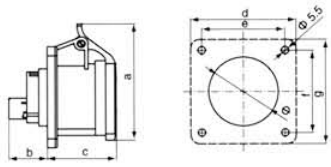
图纸/尺寸 (单位: mm)

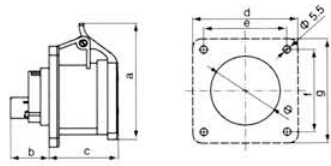
	产品名称	产品型号	电流 (A)	接地位置	电压	极数	防护等级		
	插头	HFM-217	16	4h	100-130V~	2P+E	IP67		
	插头	HFM-229	32	4h	100-130V~	2P+E	IP67		
	尺寸								电线截面积 (mm <sup>2</sup> )
	型号	a	b	c	d	e	f	g.	Φ
	HFM-217	81	32	55	75	61	61	75	55
HFM-229	99	41	65	75	61	61	75	63	2.5-6

	产品名称	产品型号	电流 (A)	接地位置	电压	极数	防护等级		
	插头	HFM-218	16	6h	220-250V~	2P+E	IP67		
	插头	HFM-230	32	6h	220-250V~	2P+E	IP67		
	尺寸								电线截面积 (mm <sup>2</sup> )
	型号	a	b	c	d	e	f	g.	Φ
	HFM-218	81	33	55	76.5	61	61	76.5	55
HFM-230	99	41	65	76.5	61	61	76.5	63	2.5-6

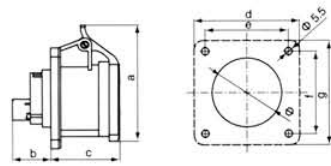
	产品名称	产品型号	电流 (A)	接地位置	电压	极数	防护等级		
	插头	HFM-222	16	6h	380-415V~	3P+E	IP67		
	插头	HFM-230	32	6h	380-415V~	3P+E	IP67		
	尺寸								电线截面积 (mm <sup>2</sup> )
	型号	a	b	c	d	e	f	g.	Φ
	HFM-222	91	31	55	76.5	61	61	76.5	59
HFM-230	99	41	65	76.5	61	61	76.5	63	2.5-6

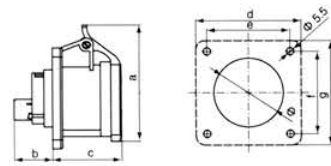
	产品名称	产品型号	电流 (A)	接地位置	电压	极数	防护等级		
	插头	HFM-228	16	6h	220-380V~ 240-415V~	3P+N+E	IP67		
	插头	HFM-240	32	6h	220-380V~ 240-415V~	3P+N+E	IP67		
	尺寸								电线截面积 (mm <sup>2</sup> )
	型号	a	b	c	d	e	f	g.	Φ
	HFM-228	94	31	58	76.5	61	61	76.5	60
HFM-240	240	40	67	76.5	61	61	76.5	67	2.5-6





110V 50a.60Hz			230V 50a.60Hz			400V 50a.60Hz			500V 50a.60Hz			>50-500V 100-300Hz			>50-500V 300-300Hz		
3pol 4h	4pol 4h	5pol 4h	3pol 6h	4pol 9h	5pol 9h	3pol 9h	4pol 6h	5pol 6h	3pol 7h	4pol 7h	5pol 7h	3pol 10h	4pol 10h	5pol 10h	3pol 2h	4pol 2h	5pol 2h

## 工业用插头、插座、耦合器（连接器）及接插装置

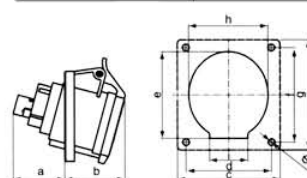
图纸/尺寸 (单位: mm)

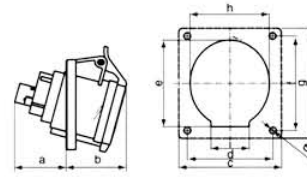
	产品名称	产品型号	电流 (A)	接地位置	电压	极数	防护等级					
	插头	HFM-1462	16	4h	100-130V~	2P+E	IP44					
	插头	HFM-1491	32	4h	100-130V~	2P+E	IP44					
	尺寸											
	型号	a	b	c	d	e	f	g.	h	i	Φ	电线截面积 (mm <sup>2</sup> )
	HFM-1462	45	48	64	52.5	63	60.5	73.5	53	-	5.5	1.5-4
HFM-1491	40	58	93	78	83	86	100	70	42	5.5	2.5-6	

	产品名称	产品型号	电流 (A)	接地位置	电压	极数	防护等级					
	插头	HFM-1463	16	6h	220-250V~	2P+E	IP44					
	插头	HFM-1492	32	6h	220-250V~	2P+E	IP44					
	尺寸											
	型号	a	b	c	d	e	f	g.	h	i	Φ	电线截面积 (mm <sup>2</sup> )
	HFM-1463	45	48	64	52.5	63	60.5	73.5	53	-	5.5	1.5-4
HFM-1492	40	58	93	78	83	86	100	70	42	5.5	2.5-6	

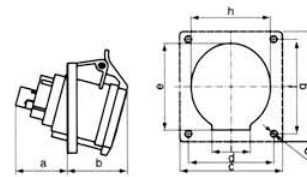

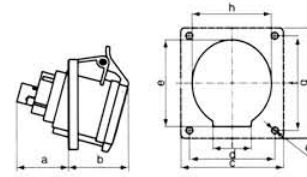



	产品名称	产品型号	电流 (A)	接地位置	电压	极数	防护等级					
	插头	HFM-1467	16	6h	380-415V~	3P+E	IP44					
	插头	HFM-1496	32	6h	380-415V~	3P+E	IP44					
	尺寸											
	型号	a	b	c	d	e	f	g.	h	i	Φ	电线截面积 (mm <sup>2</sup> )
	HFM-1467	40	55	92	78	73	86	100	73	-	5.5	1.5-4
HFM-1496	53	60	92	78	73	86	100	73	42	5.5	2.5-6	

	产品名称	产品型号	电流 (A)	接地位置	电压	极数	防护等级					
	插头	HFM-1473	16	6h	220-380V~ 240-415V~	3P+N+E	IP44					
	插头	HFM-1500	32	6h	220-380V~ 240-415V~	3P+N+E	IP44					
	尺寸											
	型号	a	b	c	d	e	f	g.	h	i	Φ	电线截面积 (mm <sup>2</sup> )
	HFM-105	40	53	92	78	75	86	100	75	-	5.5	1.5-4
HFM-1425	56	63	92	78	85	86	100	75	42	5.5	2.5-6	

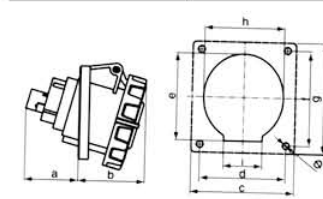
110V 50a.60Hz			230V 50a.60Hz			400V 50a.60Hz			500V 50a.60Hz			>50-500V 100-300Hz			>50-500V 300-300Hz		
3pol 4h	4pol 4h	5pol 4h	3pol 6h	4pol 9h	5pol 9h	3pol 9h	4pol 6h	5pol 6h	3pol 7h	4pol 7h	5pol 7h	3pol 10h	4pol 10h	5pol 10h	3pol 2h	4pol 2h	5pol 2h

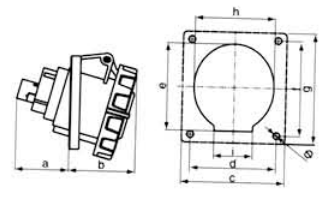
## 工业用插头、插座、耦合器（连接器）及接插装置

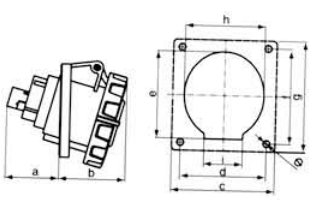
图纸/尺寸 (单位: mm)

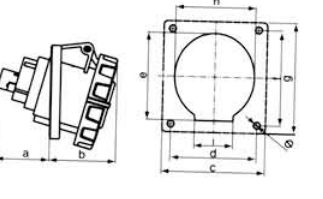
	<table border="1"> <thead> <tr> <th>产品名称</th> <th>产品型号</th> <th>电流 (A)</th> <th>接地位置</th> <th>电压</th> <th>极数</th> <th>防护等级</th> </tr> </thead> <tbody> <tr> <td>插头</td> <td>HFM-1474</td> <td>16</td> <td>4h</td> <td>100-130V~</td> <td>2P+E</td> <td>IP67</td> </tr> <tr> <td>插头</td> <td>HFM-1501</td> <td>32</td> <td>4h</td> <td>100-130V~</td> <td>2P+E</td> <td>IP67</td> </tr> </tbody> </table>	产品名称	产品型号	电流 (A)	接地位置	电压	极数	防护等级	插头	HFM-1474	16	4h	100-130V~	2P+E	IP67	插头	HFM-1501	32	4h	100-130V~	2P+E	IP67	 <table border="1"> <thead> <tr> <th rowspan="2">尺寸 型号</th> <th colspan="11">尺寸</th> <th rowspan="2">电线截面积 (mm<sup>2</sup>)</th> </tr> <tr> <th>a</th> <th>b</th> <th>c</th> <th>d</th> <th>e</th> <th>f</th> <th>g</th> <th>h</th> <th>i</th> <th>Φ</th> </tr> </thead> <tbody> <tr> <td>HFM-1462</td> <td>40</td> <td>48</td> <td>64</td> <td>52.5</td> <td>63</td> <td>60.5</td> <td>73.5</td> <td>53</td> <td>-</td> <td>5.5</td> <td>1.5-4</td> </tr> <tr> <td>HFM-1491</td> <td>57</td> <td>62</td> <td>92</td> <td>78</td> <td>83</td> <td>86</td> <td>100</td> <td>70</td> <td>42</td> <td>5.5</td> <td>2.5-6</td> </tr> </tbody> </table>	尺寸 型号	尺寸											电线截面积 (mm <sup>2</sup> )	a	b	c	d	e	f	g	h	i	Φ	HFM-1462	40	48	64	52.5	63	60.5	73.5	53	-	5.5	1.5-4	HFM-1491	57	62	92	78	83	86	100	70	42	5.5	2.5-6
	产品名称	产品型号	电流 (A)	接地位置	电压	极数	防护等级																																																															
	插头	HFM-1474	16	4h	100-130V~	2P+E	IP67																																																															
插头	HFM-1501	32	4h	100-130V~	2P+E	IP67																																																																
尺寸 型号	尺寸											电线截面积 (mm <sup>2</sup> )																																																										
	a	b	c	d	e	f	g	h	i	Φ																																																												
HFM-1462	40	48	64	52.5	63	60.5	73.5	53	-	5.5	1.5-4																																																											
HFM-1491	57	62	92	78	83	86	100	70	42	5.5	2.5-6																																																											
	<table border="1"> <thead> <tr> <th>产品名称</th> <th>产品型号</th> <th>电流 (A)</th> <th>接地位置</th> <th>电压</th> <th>极数</th> <th>防护等级</th> </tr> </thead> <tbody> <tr> <td>插头</td> <td>HFM-1475</td> <td>16</td> <td>6h</td> <td>220-250V~</td> <td>2P+E</td> <td>IP67</td> </tr> <tr> <td>插头</td> <td>HFM-1502</td> <td>32</td> <td>6h</td> <td>220-250V~</td> <td>2P+E</td> <td>IP67</td> </tr> </tbody> </table>	产品名称	产品型号	电流 (A)	接地位置	电压	极数	防护等级	插头	HFM-1475	16	6h	220-250V~	2P+E	IP67	插头	HFM-1502	32	6h	220-250V~	2P+E	IP67	 <table border="1"> <thead> <tr> <th rowspan="2">尺寸 型号</th> <th colspan="11">尺寸</th> <th rowspan="2">电线截面积 (mm<sup>2</sup>)</th> </tr> <tr> <th>a</th> <th>b</th> <th>c</th> <th>d</th> <th>e</th> <th>f</th> <th>g</th> <th>h</th> <th>i</th> <th>Φ</th> </tr> </thead> <tbody> <tr> <td>HFM-1475</td> <td>40</td> <td>48</td> <td>64</td> <td>52.5</td> <td>63</td> <td>60.5</td> <td>73.5</td> <td>53</td> <td>-</td> <td>5.5</td> <td>1.5-4</td> </tr> <tr> <td>HFM-1502</td> <td>57</td> <td>62</td> <td>92</td> <td>78</td> <td>83</td> <td>86</td> <td>100</td> <td>70</td> <td>42</td> <td>5.5</td> <td>2.5-6</td> </tr> </tbody> </table>	尺寸 型号	尺寸											电线截面积 (mm <sup>2</sup> )	a	b	c	d	e	f	g	h	i	Φ	HFM-1475	40	48	64	52.5	63	60.5	73.5	53	-	5.5	1.5-4	HFM-1502	57	62	92	78	83	86	100	70	42	5.5	2.5-6
	产品名称	产品型号	电流 (A)	接地位置	电压	极数	防护等级																																																															
	插头	HFM-1475	16	6h	220-250V~	2P+E	IP67																																																															
插头	HFM-1502	32	6h	220-250V~	2P+E	IP67																																																																
尺寸 型号	尺寸											电线截面积 (mm <sup>2</sup> )																																																										
	a	b	c	d	e	f	g	h	i	Φ																																																												
HFM-1475	40	48	64	52.5	63	60.5	73.5	53	-	5.5	1.5-4																																																											
HFM-1502	57	62	92	78	83	86	100	70	42	5.5	2.5-6																																																											
	<table border="1"> <thead> <tr> <th>产品名称</th> <th>产品型号</th> <th>电流 (A)</th> <th>接地位置</th> <th>电压</th> <th>极数</th> <th>防护等级</th> </tr> </thead> <tbody> <tr> <td>插头</td> <td>HFM-1479</td> <td>16</td> <td>6h</td> <td>380-415V~</td> <td>3P+E</td> <td>IP67</td> </tr> <tr> <td>插头</td> <td>HFM-1506</td> <td>32</td> <td>6h</td> <td>380-415V~</td> <td>3P+E</td> <td>IP67</td> </tr> </tbody> </table>	产品名称	产品型号	电流 (A)	接地位置	电压	极数	防护等级	插头	HFM-1479	16	6h	380-415V~	3P+E	IP67	插头	HFM-1506	32	6h	380-415V~	3P+E	IP67	 <table border="1"> <thead> <tr> <th rowspan="2">尺寸 型号</th> <th colspan="11">尺寸</th> <th rowspan="2">电线截面积 (mm<sup>2</sup>)</th> </tr> <tr> <th>a</th> <th>b</th> <th>c</th> <th>d</th> <th>e</th> <th>f</th> <th>g</th> <th>h</th> <th>i</th> <th>Φ</th> </tr> </thead> <tbody> <tr> <td>HFM-1479</td> <td>40</td> <td>55</td> <td>92</td> <td>78</td> <td>73</td> <td>86</td> <td>100</td> <td>73</td> <td>-</td> <td>5.5</td> <td>1.5-4</td> </tr> <tr> <td>HFM-1506</td> <td>57</td> <td>62</td> <td>92</td> <td>78</td> <td>73</td> <td>86</td> <td>100</td> <td>73</td> <td>42</td> <td>5.5</td> <td>2.5-6</td> </tr> </tbody> </table>	尺寸 型号	尺寸											电线截面积 (mm <sup>2</sup> )	a	b	c	d	e	f	g	h	i	Φ	HFM-1479	40	55	92	78	73	86	100	73	-	5.5	1.5-4	HFM-1506	57	62	92	78	73	86	100	73	42	5.5	2.5-6
	产品名称	产品型号	电流 (A)	接地位置	电压	极数	防护等级																																																															
	插头	HFM-1479	16	6h	380-415V~	3P+E	IP67																																																															
插头	HFM-1506	32	6h	380-415V~	3P+E	IP67																																																																
尺寸 型号	尺寸											电线截面积 (mm <sup>2</sup> )																																																										
	a	b	c	d	e	f	g	h	i	Φ																																																												
HFM-1479	40	55	92	78	73	86	100	73	-	5.5	1.5-4																																																											
HFM-1506	57	62	92	78	73	86	100	73	42	5.5	2.5-6																																																											
	<table border="1"> <thead> <tr> <th>产品名称</th> <th>产品型号</th> <th>电流 (A)</th> <th>接地位置</th> <th>电压</th> <th>极数</th> <th>防护等级</th> </tr> </thead> <tbody> <tr> <td>插头</td> <td>HFM-1485</td> <td>16</td> <td>6h</td> <td>220-380V~ 240-415V~</td> <td>3P+N+E</td> <td>IP67</td> </tr> <tr> <td>插头</td> <td>HFM-1551</td> <td>32</td> <td>6h</td> <td>220-380V~ 240-415V~</td> <td>3P+N+E</td> <td>IP67</td> </tr> </tbody> </table>	产品名称	产品型号	电流 (A)	接地位置	电压	极数	防护等级	插头	HFM-1485	16	6h	220-380V~ 240-415V~	3P+N+E	IP67	插头	HFM-1551	32	6h	220-380V~ 240-415V~	3P+N+E	IP67	 <table border="1"> <thead> <tr> <th rowspan="2">尺寸 型号</th> <th colspan="11">尺寸</th> <th rowspan="2">电线截面积 (mm<sup>2</sup>)</th> </tr> <tr> <th>a</th> <th>b</th> <th>c</th> <th>d</th> <th>e</th> <th>f</th> <th>g</th> <th>h</th> <th>i</th> <th>Φ</th> </tr> </thead> <tbody> <tr> <td>HFM-1485</td> <td>43</td> <td>59</td> <td>92</td> <td>78</td> <td>75</td> <td>86</td> <td>100</td> <td>75</td> <td>-</td> <td>5.5</td> <td>1.5-4</td> </tr> <tr> <td>HFM-1551</td> <td>60</td> <td>64</td> <td>92</td> <td>78</td> <td>85</td> <td>86</td> <td>100</td> <td>75</td> <td>42</td> <td>5.5</td> <td>2.5-6</td> </tr> </tbody> </table>	尺寸 型号	尺寸											电线截面积 (mm <sup>2</sup> )	a	b	c	d	e	f	g	h	i	Φ	HFM-1485	43	59	92	78	75	86	100	75	-	5.5	1.5-4	HFM-1551	60	64	92	78	85	86	100	75	42	5.5	2.5-6
	产品名称	产品型号	电流 (A)	接地位置	电压	极数	防护等级																																																															
	插头	HFM-1485	16	6h	220-380V~ 240-415V~	3P+N+E	IP67																																																															
插头	HFM-1551	32	6h	220-380V~ 240-415V~	3P+N+E	IP67																																																																
尺寸 型号	尺寸											电线截面积 (mm <sup>2</sup> )																																																										
	a	b	c	d	e	f	g	h	i	Φ																																																												
HFM-1485	43	59	92	78	75	86	100	75	-	5.5	1.5-4																																																											
HFM-1551	60	64	92	78	85	86	100	75	42	5.5	2.5-6																																																											

110V 50a.60Hz			230V 50a.60Hz			400V 50a.60Hz			500V 50a.60Hz			>50-500V 100-300Hz			>50-500V 300-300Hz		
3pol 4h	4pol 4h	5pol 4h	3pol 6h	4pol 9h	5pol 9h	3pol 9h	4pol 6h	5pol 6h	3pol 7h	4pol 7h	5pol 7h	3pol 10h	4pol 10h	5pol 10h	3pol 2h	4pol 2h	5pol 2h

## 工业用插头、插座、耦合器（连接器）及接插装置

图纸/尺寸 (单位: mm)

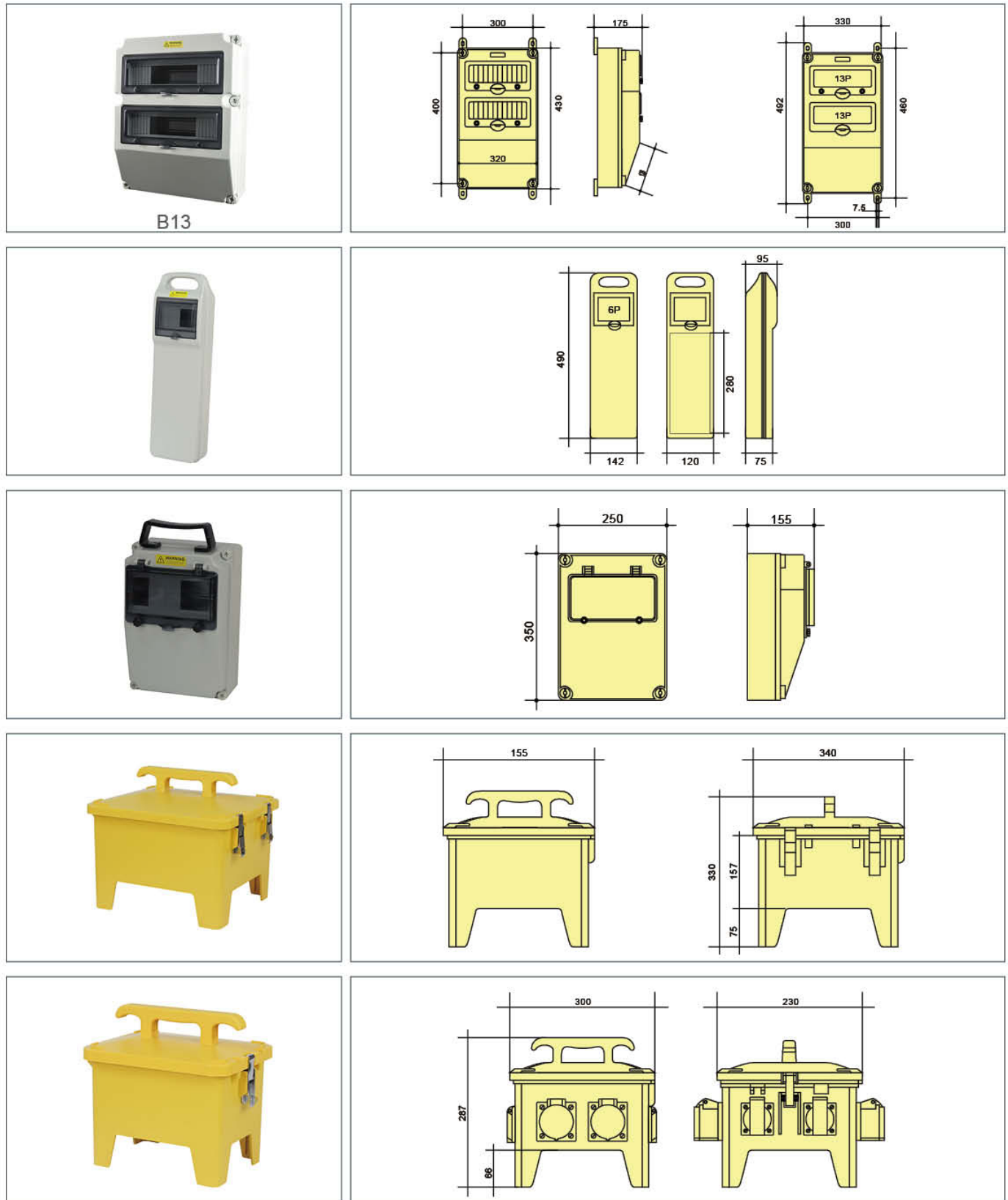



110V 50a.60Hz			230V 50a.60Hz			400V 50a.60Hz			500V 50a.60Hz			>50-500V 100-300Hz			>50-500V 300-300Hz		
3pol 4h	4pol 4h	5pol 4h	3pol 6h	4pol 9h	5pol 9h	3pol 9h	4pol 6h	5pol 6h	3pol 7h	4pol 7h	5pol 7h	3pol 10h	4pol 10h	5pol 10h	3pol 2h	4pol 2h	5pol 2h

## 工业用插头、插座、耦合器（连接器）及接插装置

图纸/尺寸 (单位: mm)

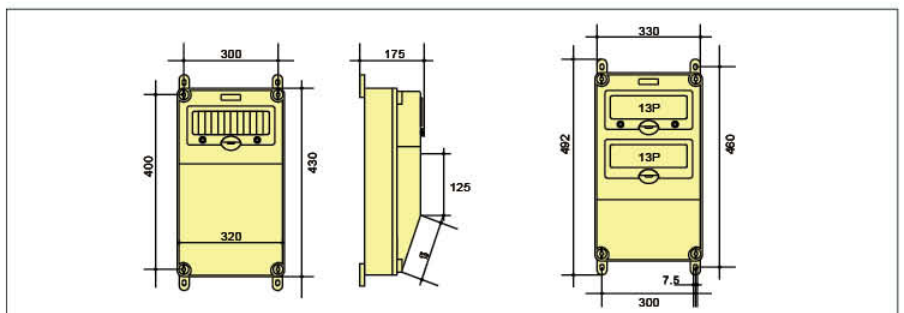
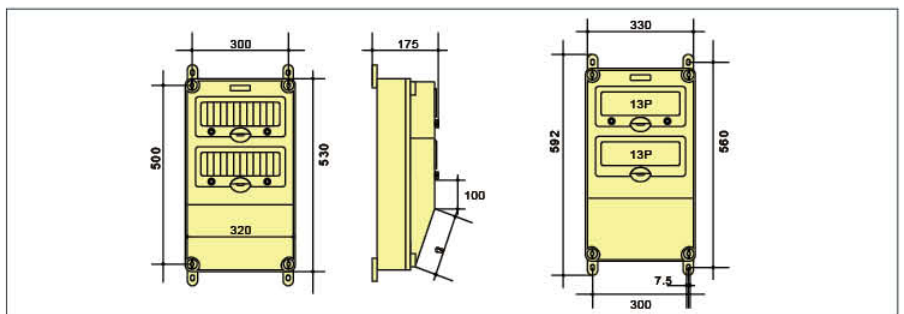
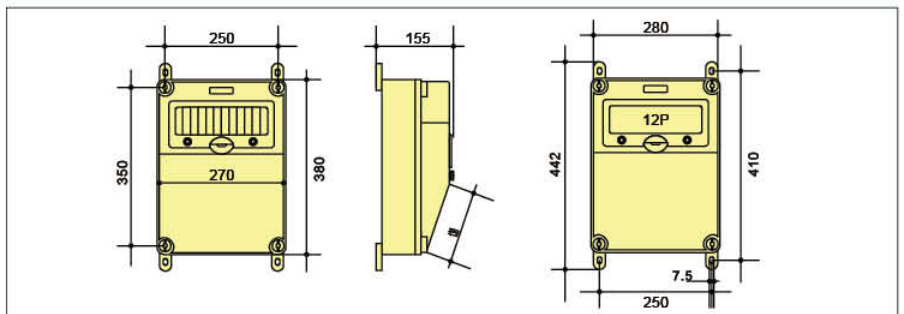
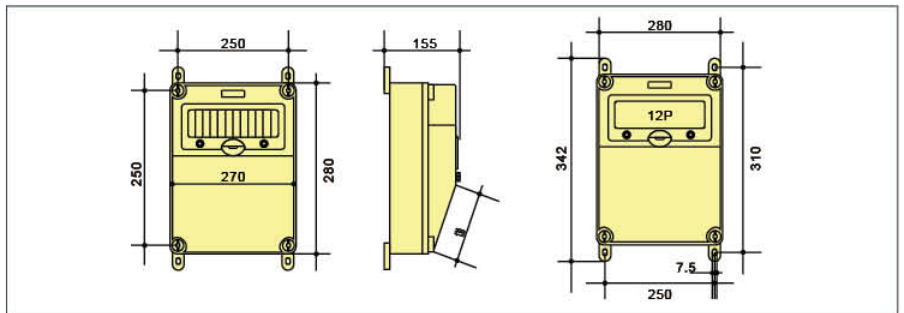
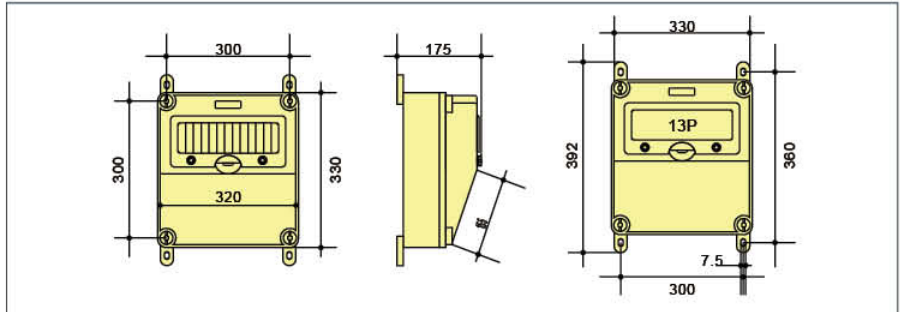



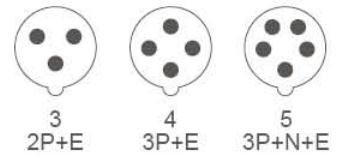

110V 50a.60Hz			230V 50a.60Hz			400V 50a.60Hz			500V 50a.60Hz			>50-500V 100-300Hz			>50-500V 300-300Hz		
3pol 4h	4pol 4h	5pol 4h	3pol 6h	4pol 9h	5pol 9h	3pol 9h	4pol 6h	5pol 6h	3pol 7h	4pol 7h	5pol 7h	3pol 10h	4pol 10h	5pol 10h	3pol 2h	4pol 2h	5pol 2h

**工业用插头、插座、耦合器（连接器）及接插装置**

图纸/尺寸 (单位: mm)





采用环保纸印刷，珍惜资源，善待环境  
Take good care of the resources, Be kind to the environment

## 乐清市禾丰电气有限公司

YUEQING CITY HEFENG ELECTRIC CO.,LTD.

地址：浙江省乐清市温州大桥工业区

手机：18858775252

电话：0577-27773399

传真：0577-87936663

QQ：87793806

网址：[HTTP://WWW.SUOKAI.CC](http://www.suokai.cc)



• 本资料由禾丰电气监制，仅用于展示本企业产品资料的相关信息，禾丰电气随时可能因样本资料更新而改进本资料相关内容，或对本资料的印刷错误及不准确的信息进行必要的改进和更改，恕不另行通知。